

ORION PCAP professional display

- Wide dynamic range of Interactive 32" ~ 86"



Features

Design

- ✓ Edge to edge glass (Bezel free)
- ✓ Robust metal works
- ✓ All rounded 4 corners
- ✓ VESA wall & Side mountable

Display

- ✓ Long term usable commercial LCD panel (24/7/365)
- ✓ Ultra HD resolution
- ✓ Compatible panel for
 - Landscape, Portrait, Table

Functionality

- ✓ Fastest P-CAP touch (10p/50p)
- ✓ Alternative interface
 - HDMI, DP, DVI, VGA
- ✓ Ventilation FAN

Option

- ✓ PC / Android built in
- ✓ Various glass coating (AR, AG, AF, Mirror etc)
- ✓ Screen rotation button



Specification

Model	OLSK-3250CP	OLSK-4350CP	OLSK-4650CP	OLSK-5550CP	OLSK-6550CP	OLSK-8650CP	
Panel Size (inch)	32	43	46	55	65	86	
Aspect Ratio	16:9	16:9	16:9	16:9	16:9	16:9	
Max. Resolution	FHD	UHD	FHD	UHD	UHD	UHD	
Contrast Ratio (Typ.)	1300:1	1000:1	4000:1	1100:1	1100:1	1200:1	
Brightness (panel) cd/m ²	450	400	500	500	500	500	
Viewing Angle (H)/(V) (Typ.)	178°/178°	178°/178°	178°/178°	178°/178°	178°/178°	178°/178°	
Input Signal	HDMI, DVI-D, VGA	HDMI 2.0 x 2 DP 1.2 x 2	HDMI, DVI-D, VGA	HDMI 2.0 x 2 DP 1.2 x 2	HDMI 2.0 x 2 DP 1.2 x 2	HDMI 2.0 x 2 DP 1.2 x 2	
Audio	Input/output	HDMI Φ3.5 Phone Jack Speaker	HDMI DP	HDMI Φ3.5 Phone Jack Speaker	HDMI, DP Φ3.5 Phone Jack Speaker	HDMI, DP Φ3.5 Phone Jack Speaker	HDMI, DP Φ3.5 Phone Jack Speaker
	Speaker Output	10Wrms + 10Wrms (±10%)	10Wrms + 10Wrms (±10%)	10Wrms + 10Wrms (±10%)	10Wrms + 10Wrms (±10%)	10Wrms + 10Wrms (±10%)	10Wrms + 10Wrms (±10%)
Plug & Play	VESA DDC2B		VESA DDC2B	VESA DDC2B			
Power Input	AC 100V~240V (50/60Hz)	AC 100V~240V (50/60Hz)	AC 100V~240V (50/60Hz)	AC 100V~240V (50/60Hz)	AC 100V~240V (50/60Hz)	AC 100V~240V (50/60Hz)	
Touch Technology	PCAP	PCAP	PCAP	PCAP	PCAP	PCAP	
Touch Input Method	Finger, Pen (Capacitive)	Finger, Pen (Capacitive)	Finger, Pen (Capacitive)	Finger, Pen (Capacitive)	Finger, Pen (Capacitive)	Finger, Pen (Capacitive)	

■ The specification is subject to change without prior notice

www.oriondisplay.net

등급	공차		
	I	II	III
범위			
0 ~ 4 이하	±0.1	±0.2	±0.3
4 ~ 16 이하	±0.2		
16 ~ 63 이하	±0.3	±0.3	±0.5
63 ~ 250 이하	±0.5	±0.5	±0.8
250 ~ 1000 이하	±0.8	±0.8	±1.2
1000 ~	±1.5	±1.5	±2.3
각도			
표면거칠기			

▶Rev.	▶표면처리	▶수정일자	▶작성	▶검토	▶승인

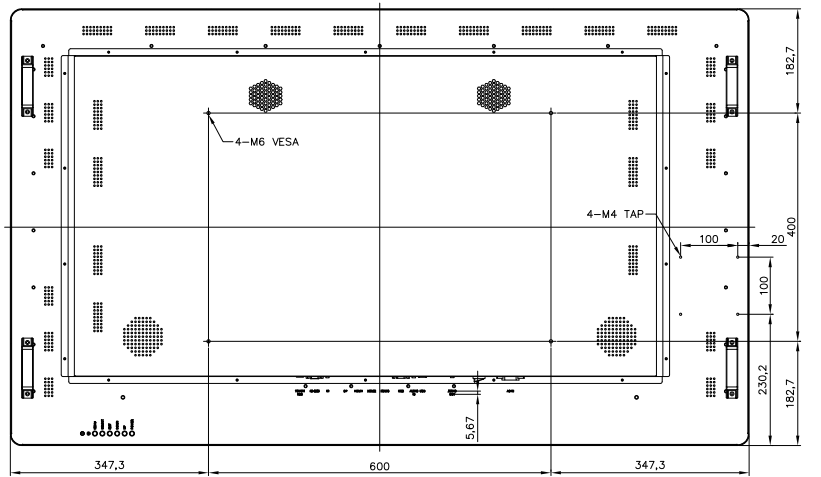
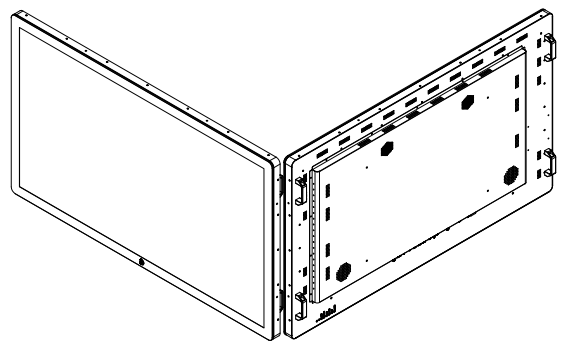
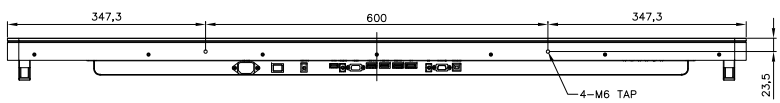
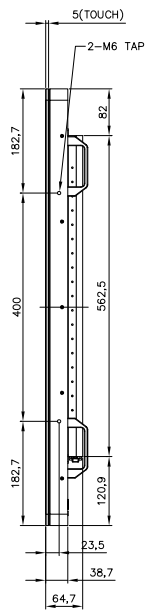
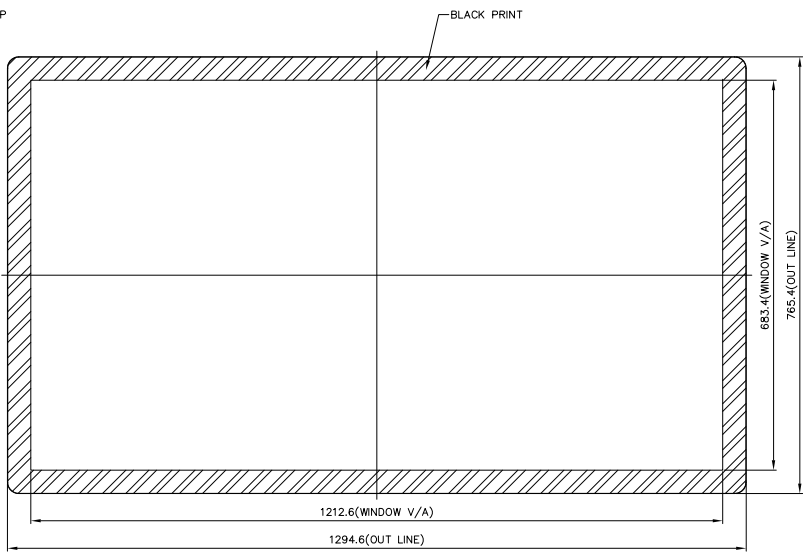
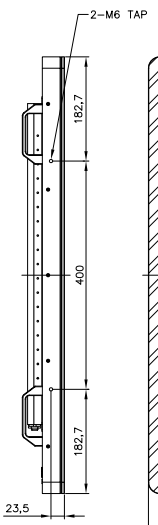
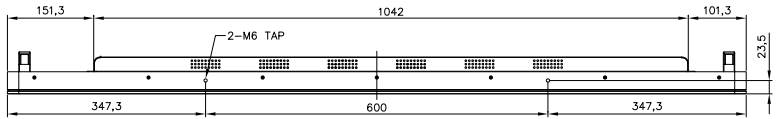

- 주 기 관
1. 재 질 : GI= 1.0t
 2. 도 장 : 약조노벨 EN 302K(BLACK)
 3. 제 작 수 량 : 1SET / 1EA
 4. 날카로운 모서리 C, R 최소로 할것.
 5. 외곽 모서리부 단차 발생 및 표면에 스크래치 주의 할것.
 6. PENNUT 사양 및 , BURRING TAP 방향에 주위 할것.

No.	PART CODE	PART NAME	MATERIAL	Q'TY	REMARKS
		GI 1.0t		1	
단위	척도	FINISH	표면처리	MODEL NAME	페이지
				IMEW550-L1P71J-UHD-AG	
	DESIGNED BY	CHECKED BY	APPROVED BY	PART NAME	
				외형도	
				PART NO.	